

# RESCUE KNOTS FOR ROCO STUDENTS

While there are many knots available to rescuers, Roco encourages mastering a few knots that are applicable for most situations. These represent a “good cross section” of the most popular rescue knots. **Remember... practice, Practice, PRACTICE!**

## STEPS IN KNOT TYING:

1. **DRESS...**Try to keep the ropes free of twists – with legs running side-by-side.
2. **LOAD...**Once tied, the knot should be pulled tight to avoid any accidental movement when line is loaded. **TEST LOAD** before life-loading!
3. **SAFETY...**Refers to securing any loose ends. If knot has a loose end (tail), it should be secured using another knot (a safety knot).
4. **PRACTICE...**Most important concept in tying knots...  
*Practice!!*

## 1. OVERHAND KNOT:

**Purpose:** Used as a Safety Knot to secure loose ends.

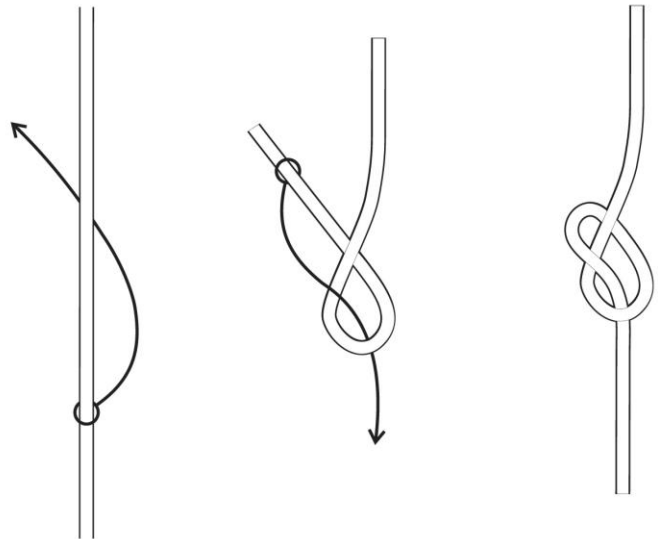

## OPTIONAL KNOT

### Barrel Knot as a safety

**Purpose:** Used as a safety knot to secure loose ends.

This knot, when used as a safety, is less likely to untie. It is used as a safety knot for hitches, when running a loaded knot over an edge or when the knot will see tensioning and slacking of the line repeatedly.

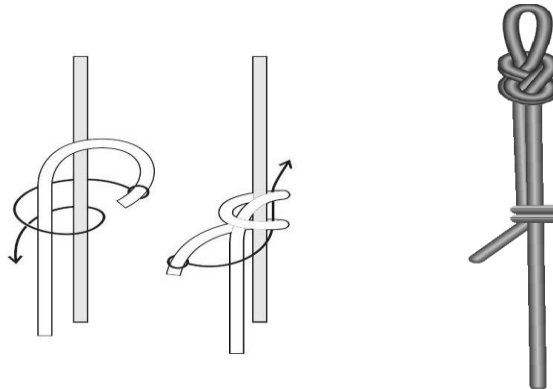

# RESCUE KNOTS FOR ROCO STUDENTS

## 2. FIGURE-8 STOPPER KNOT:

**Purpose:** Used to stop rope end from moving through a device (rappel rack, etc.).

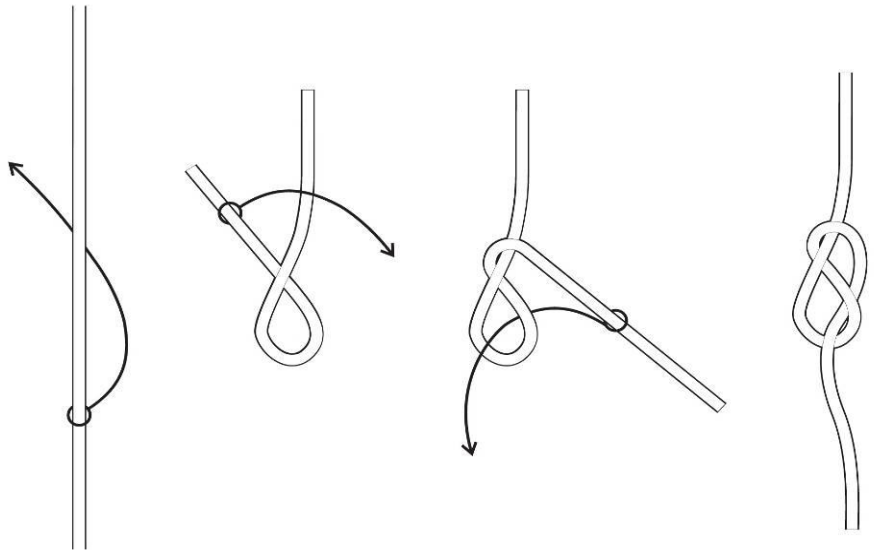
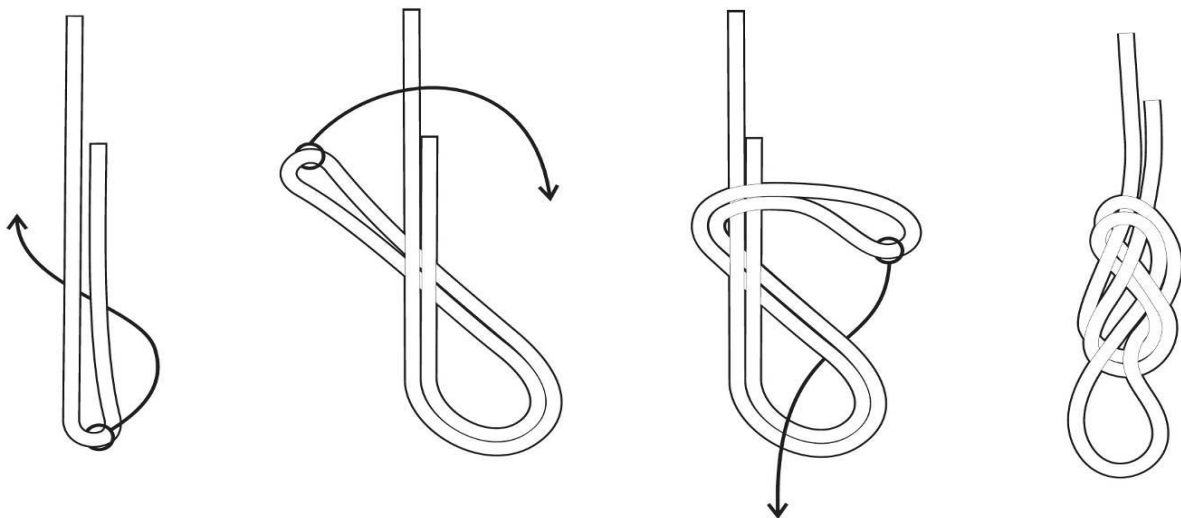

**Figure-8 Stopper Knot**

## 3. FIGURE-8 ON-A-BIGHT:

**Purpose:** Anchor knot that creates a single loop that will not slip. It can be attached to components of a rescue system with carabiners.

**Efficiency loss:** approximately 20%



**Figure-8 on-a-bight**

# RESCUE KNOTS FOR ROCO STUDENTS

## 4. DOUBLE-LOOP FIGURE-8:

**Purpose:** Anchor knot that provides more load-bearing surface area due to its two-loop configuration. It is slightly more efficient when you must tie around a tight object such as a carabiner.

**Efficiency loss:** approximately 18%

### Double-Loop Figure-8

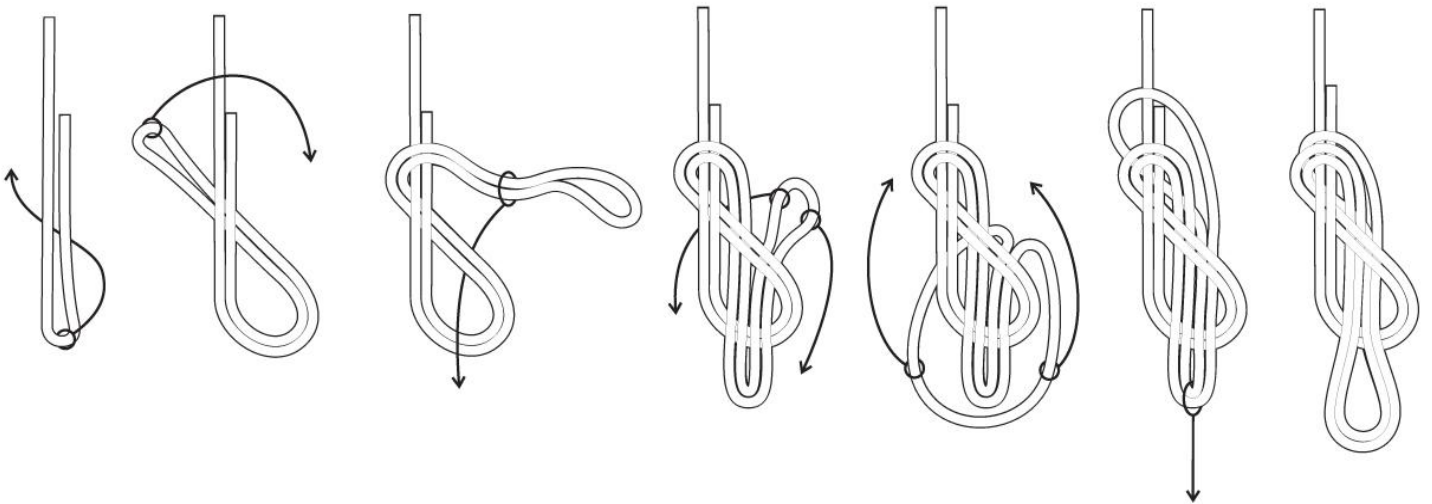

# RESCUE KNOTS FOR ROCO STUDENTS

## 5. BOWLINE KNOT:

**Purpose:** May be used as a static (non-moving) anchor knot.

**Efficiency loss:** approximately 27% to 33%

**WARNING**→ A bowline knot should **NEVER** be used in moving applications because it can untie when going over an edge. Always safety the loose end!

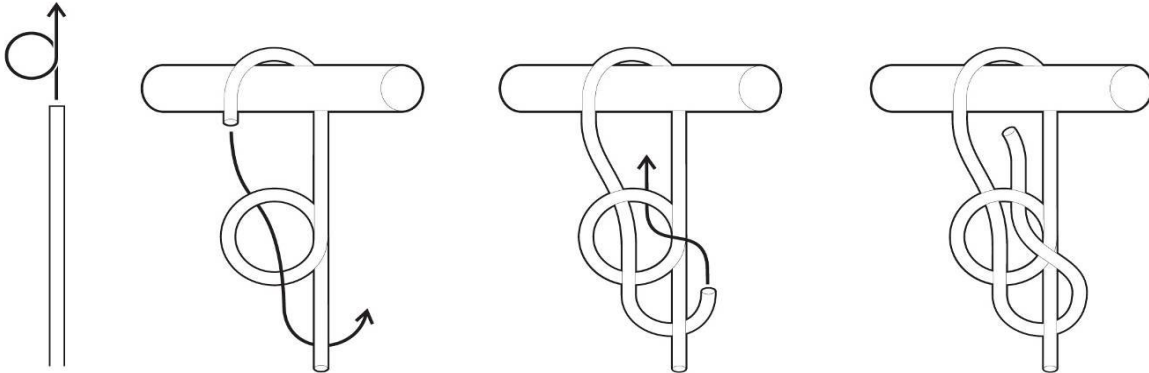

### Bowline Knot

Always safety the loose end!

## 6. DOUBLED BOWLINE KNOT:

**Purpose:** May be used as a static (non-moving) anchor knot that can be tied in the middle of a line. It is a simple Bowline tied with a bight in the line.

**WARNING**→ The bowline knot is not recommended to be used in moving applications because it can untie when going over an edge. Always safety the loose end!

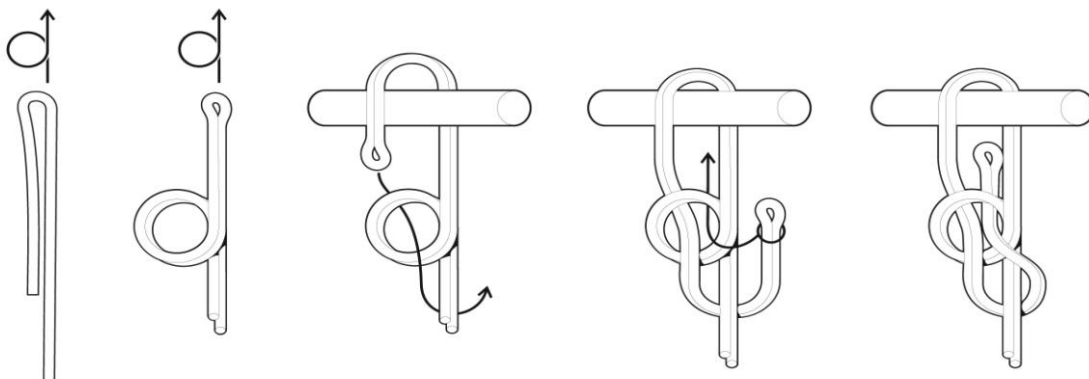

### Doubled Bowline

# RESCUE KNOTS FOR ROCO STUDENTS

## 7. FIGURE-8 FOLLOW-THROUGH KNOT:

**Purpose:** Anchor knot that can be tied around a “closed-end” object.

**Efficiency loss:** approximately 20%

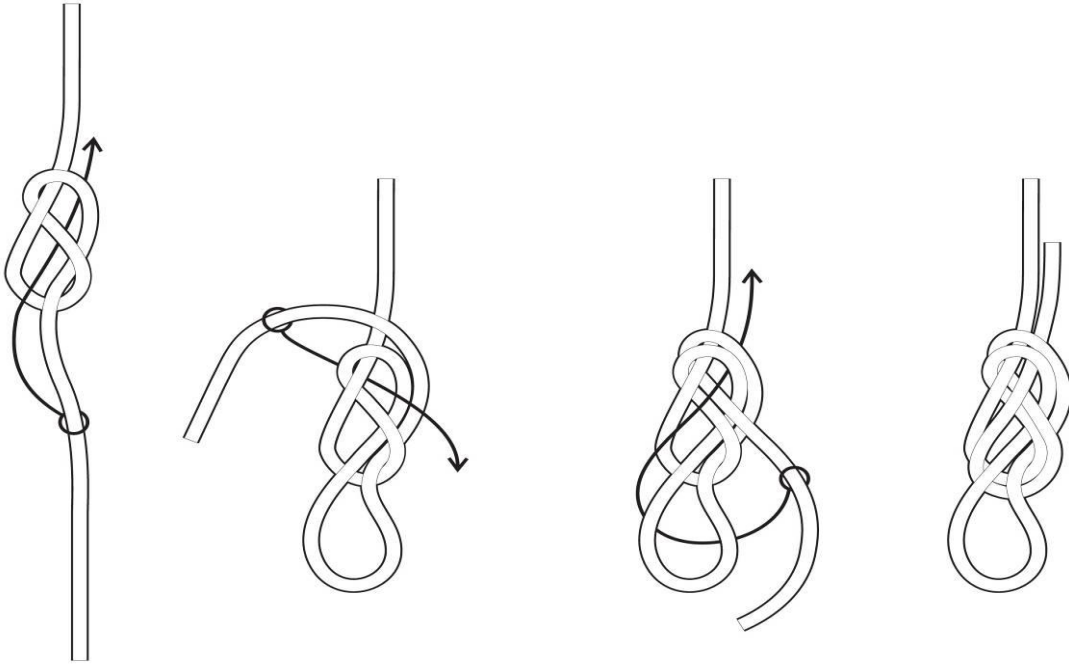

**Figure-8 Follow-Through Knot**

# RESCUE KNOTS FOR ROCO STUDENTS

## 8. CLOVE HITCH:

**Purpose:** Adjustable anchor hitch often tied to round anchor points (horizontally or vertically). It may also be tied with webbing.

**Efficiency loss:** approximately 40%

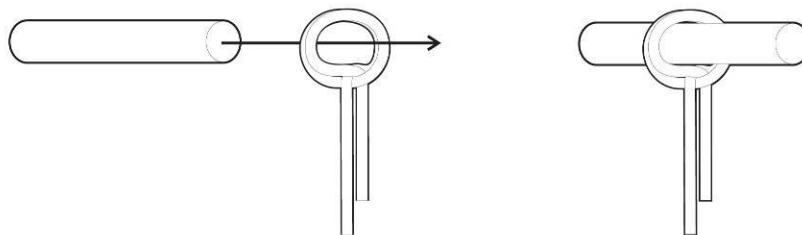
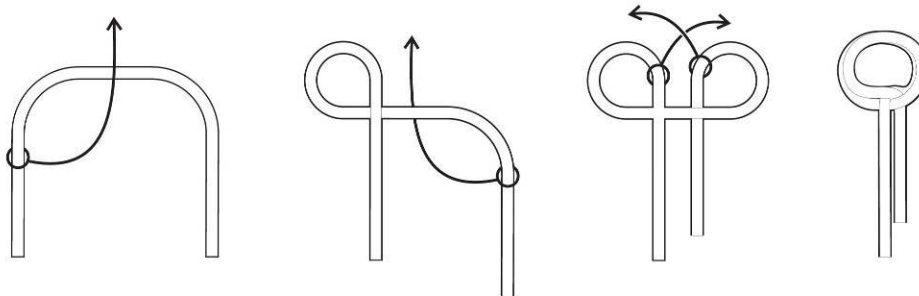
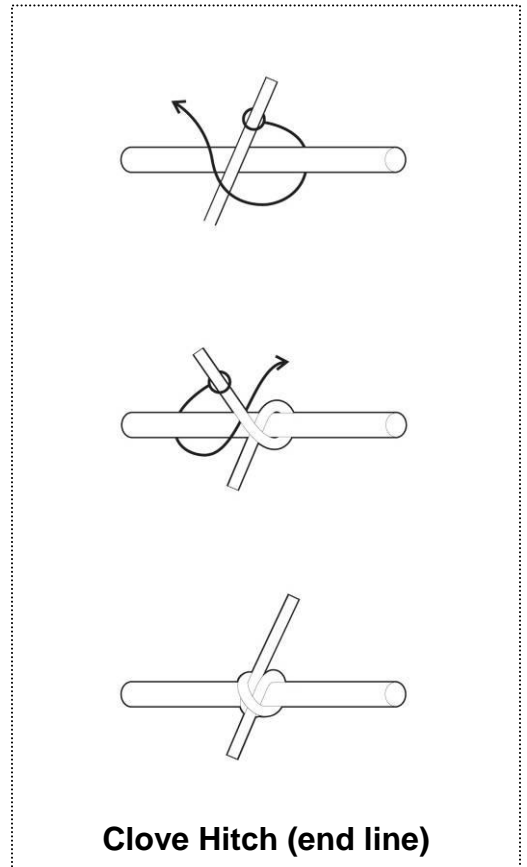

**Clove Hitch (mid-line)**

# RESCUE KNOTS FOR ROCO STUDENTS

## 9. TENSIONLESS ANCHOR (4-TO-1 WRAP):

**Purpose:** Most efficient means of anchoring a rope – as long as it's wrapped around a secure anchor at least 4 times the diameter of the rope.

1. Turns of the rope should not cross each other.
2. Minimum of three wraps.
3. Must be finished with a knot.
4. May roll on round, smooth anchors.

**Efficiency loss:** 0%

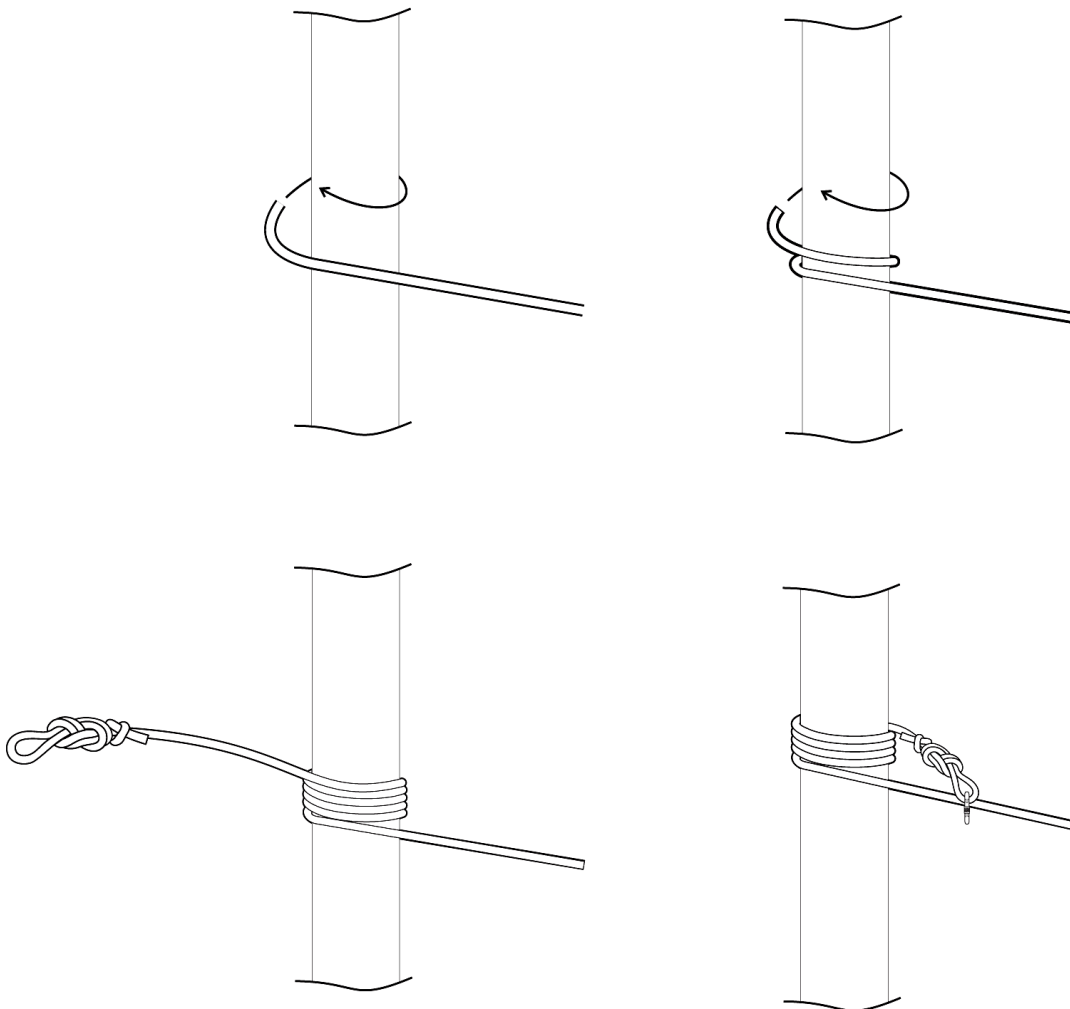

**Tensionless Anchor (4-to-1 Wrap)**

# RESCUE KNOTS FOR ROCO STUDENTS

## 10. GIRTH HITCH

**Purpose:** Used to anchor rope or webbing as a “choker.” It is the preferred method of attaching a piece of webbing to the foot-end of a backboard or metal litter when using a “Diamond Weave” to lash a patient.

**Efficiency loss:** approximately 30%

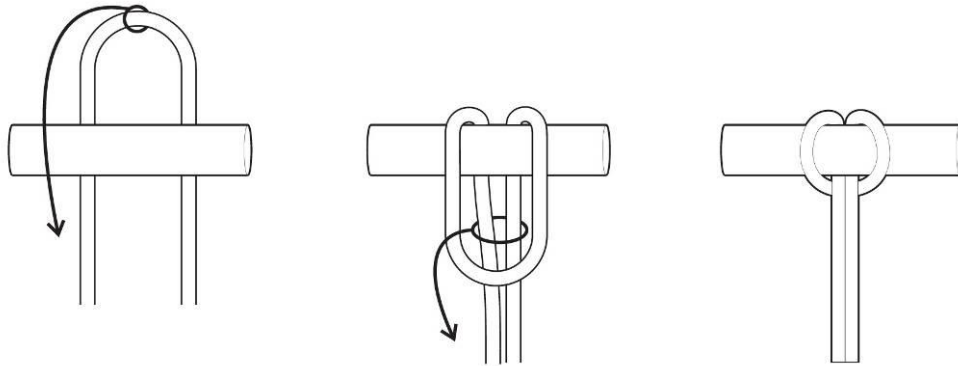

**Girth Hitch**

# RESCUE KNOTS FOR ROCO STUDENTS

## 11. BUTTERFLY KNOT:

**Purpose:** Bridle knot that provides a mid-line attachment point and is designed to take a three-directional pull.

**Efficiency loss:** approximately 25%

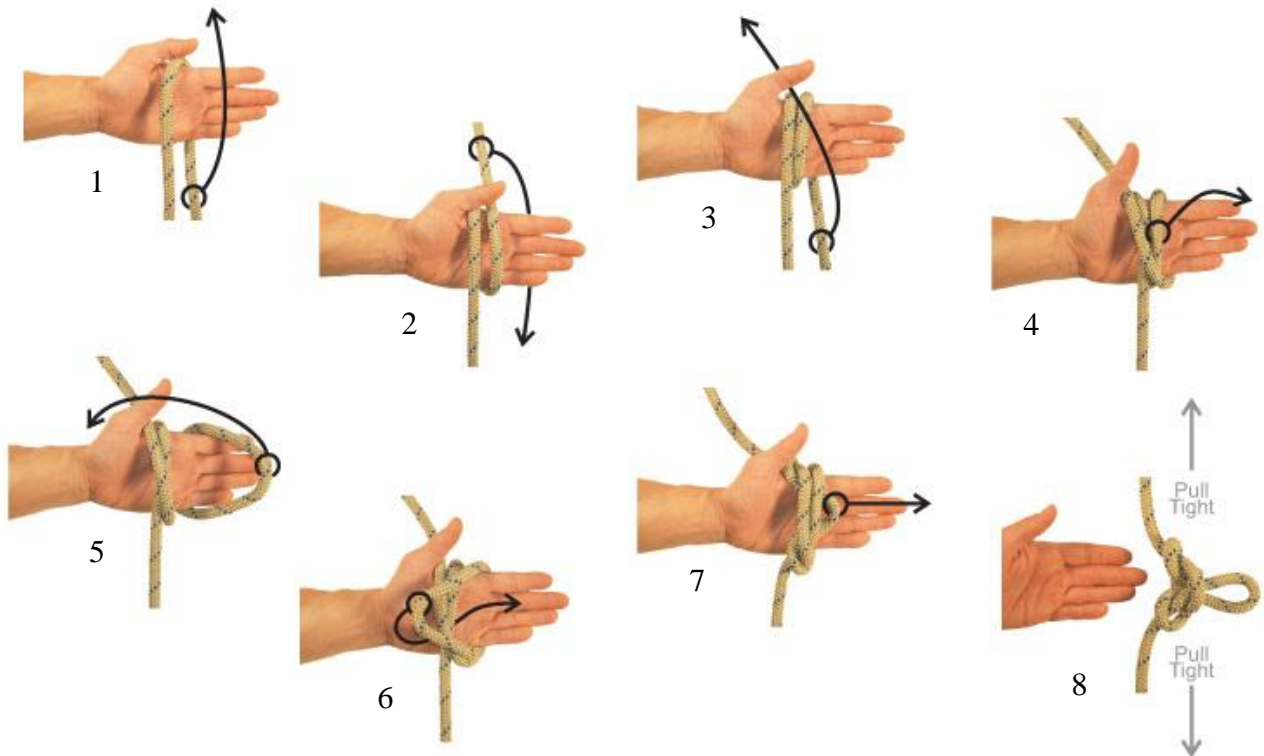

**Butterfly Knot**

# RESCUE KNOTS FOR ROCO STUDENTS

## Optional Knot

### 12. DOUBLE BUTTERFLY KNOT:

Purpose: provides more surface area round attachment hasp by forming a double loop much like the double loop -8

The knot is tied by forming four loops around your hand instead of three. Then picking up the center two loops instead of the center one and pulling both center loops back toward the thumb and out under the remaining two loops. Finish knot as usual.

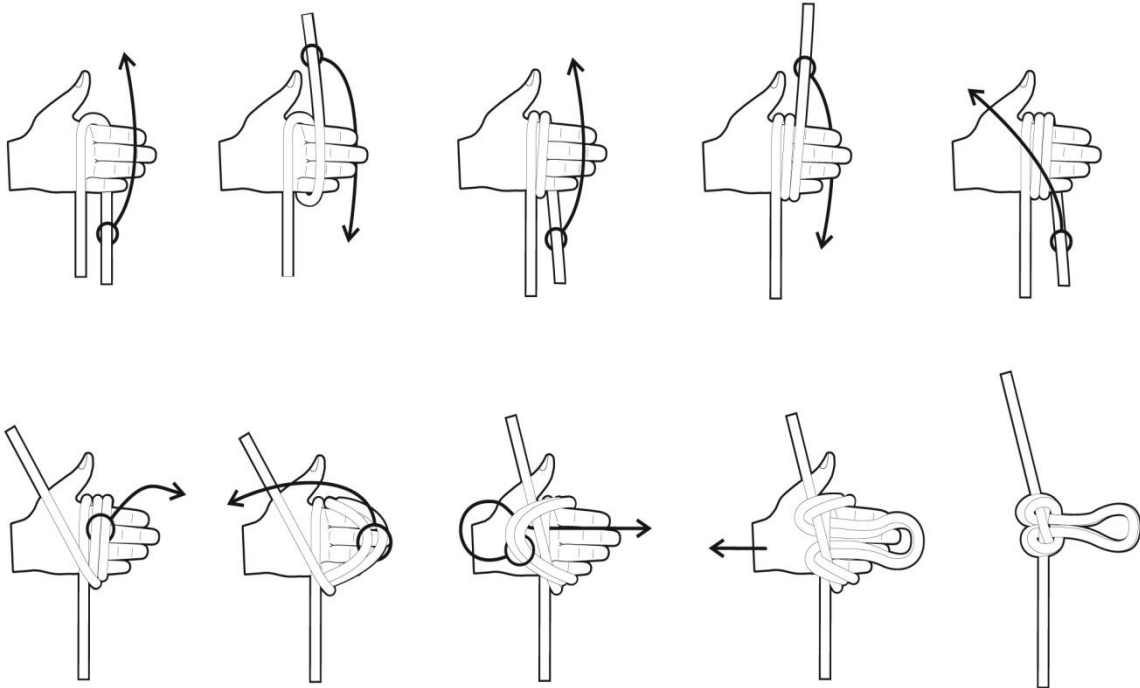

**Double Butterfly**

# RESCUE KNOTS FOR ROCO STUDENTS

## 13. DOUBLE FISHERMAN'S BEND:

**Purpose:** Used to join two ropes of equal (or slightly unequal) diameter together for load-bearing applications.

**Efficiency loss:** approximately 21%

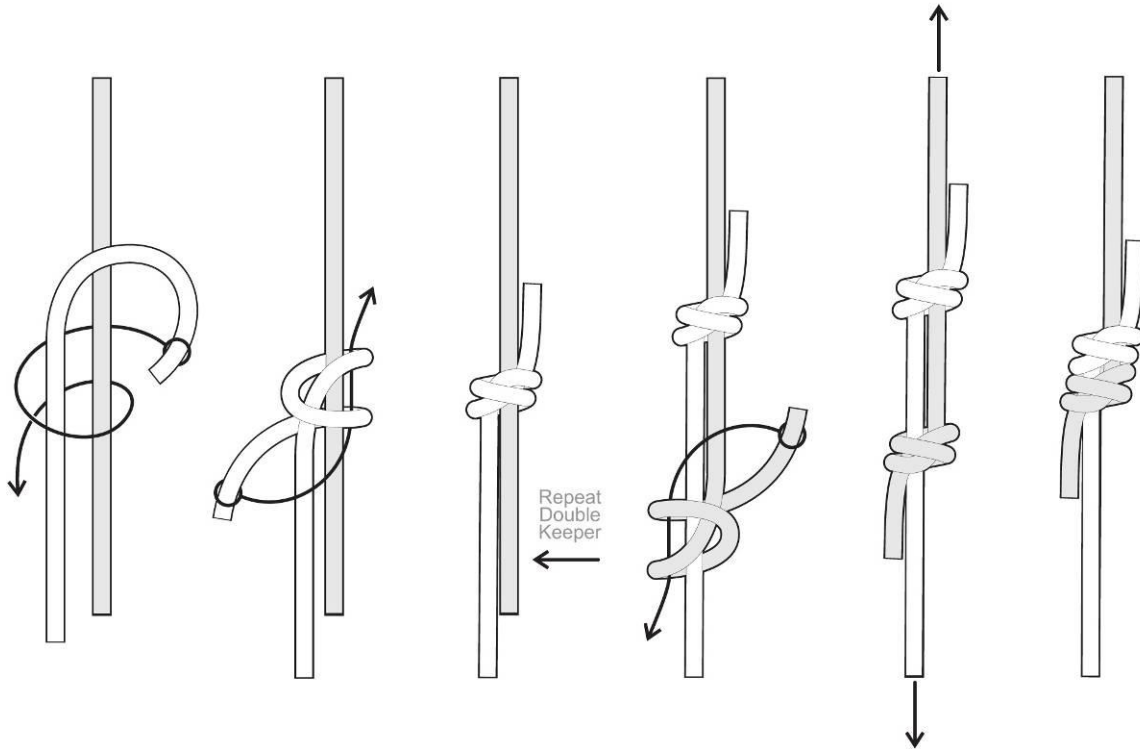

**Double Fisherman's Bend**

## 14. FIGURE-8 BEND KNOT:

**Purpose:** To join two ropes together for load bearing purposes.

**Efficiency loss:** approximately 19%

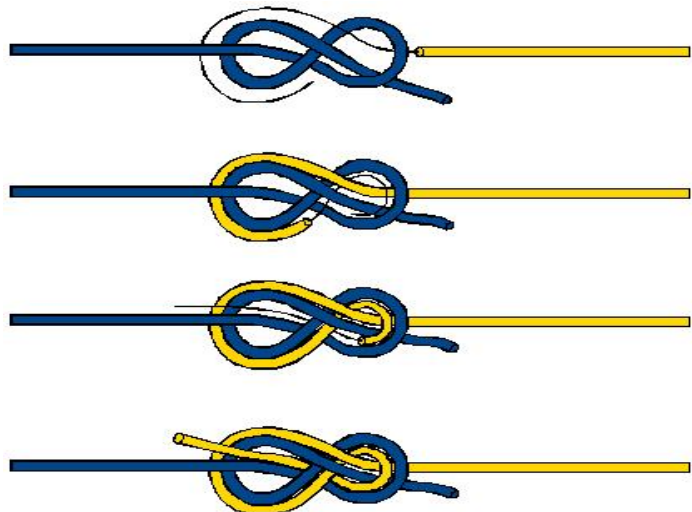

# RESCUE KNOTS FOR ROCO STUDENTS

## 15. SQUARE KNOT:

**Purpose:** Used to “bind” two ropes of the same diameter together.

**WARNING → Square knots should not be used in load-bearing applications or to support a human load!** Always safety the loose ends.

When finished, both tail ends must emerge from the same side of knot. If the rope ends emerge from opposite sides (one top, one bottom), it is not a square knot and will slip more easily when a force is applied.

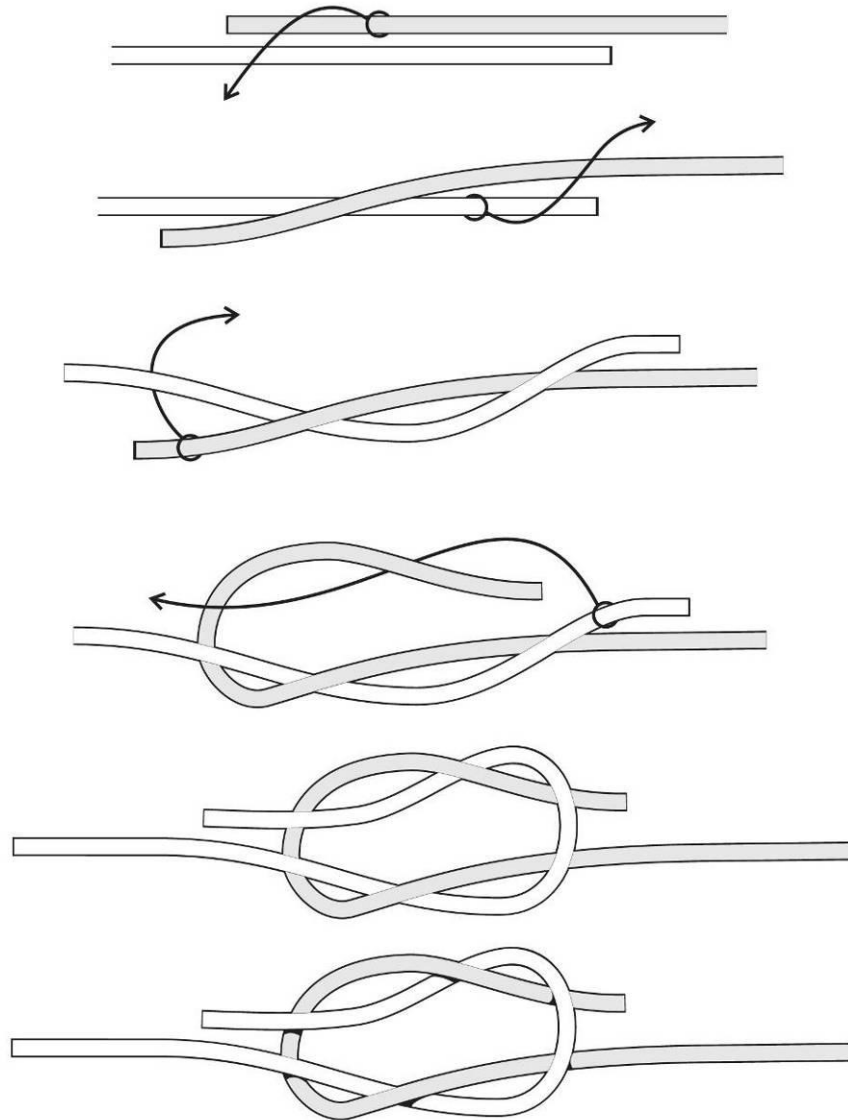

**Square Knot**  
Always safety loose ends!

# RESCUE KNOTS FOR ROCO STUDENTS

## 16. WATER KNOT:

**Purpose:** Preferred method for joining two pieces of webbing for load-bearing applications.

**Efficiency loss:** approximately 35%

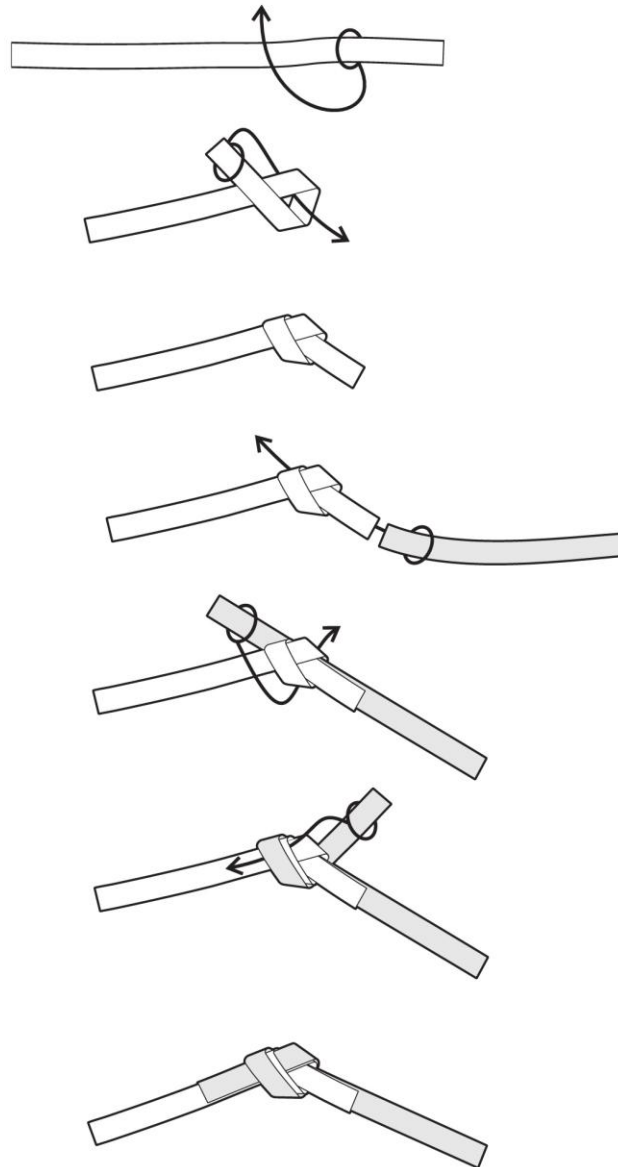

# RESCUE KNOTS FOR ROCO STUDENTS

## 17. MUNTER HITCH:

**Purpose:** Used primarily as a “belay hitch” – allows belayer to catch a falling load when properly operated.

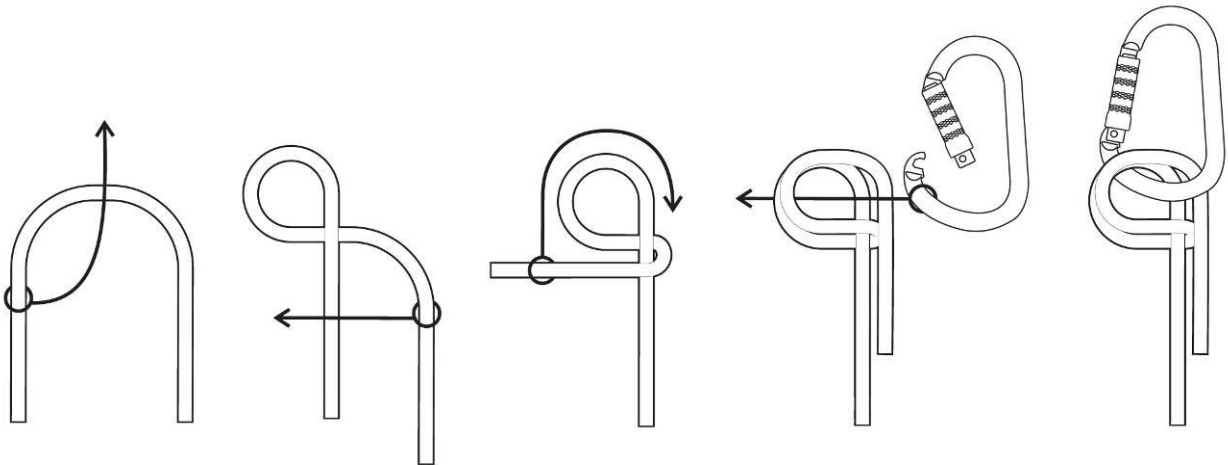

**Munter Hitch**

# RESCUE KNOTS FOR ROCO STUDENTS

## 18. WEBBING ADJUSTMENT TECHNIQUE

**Purpose:** Used to adjust the length of tubular webbing once it has been looped and doubled around an anchor.

- a. Place webbing looped with a water knot around an anchor.
- b. Grab both loops with your right hand in the thumbs down position.
- c. Place left hand through both loops.

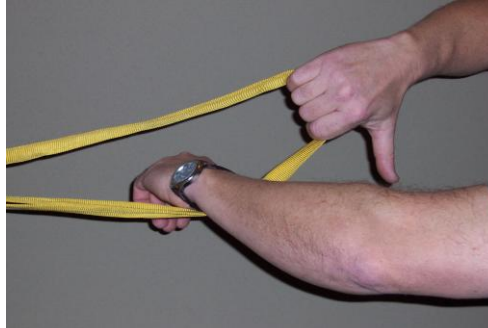

- d. Rotate right hand from thumbs down to thumbs up position.
- e. Hook loop leg on left thumb and pull leg back out with left arm.



- f. Work both loops out as you move closer to anchor.



- g. This will allow you to adjust the webbing up to half the distance to the anchor.
- h. Once webbing is at desired length, place a carabiner through all loops.

Note: These steps can be repeated to half the webbing again.

# RESCUE KNOTS FOR ROCO STUDENTS

## 19. DAISY CHAIN →

**Purpose:** Storing or transporting rope or webbing.

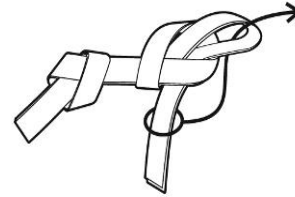
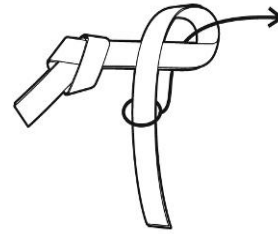
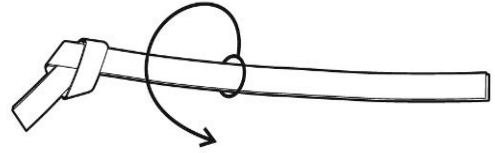

# RESCUE KNOTS FOR ROCO STUDENTS

## 20. DOUBLE-WRAP PRUSIK HITCH:

**Purpose:** Formed using a “prusik” loop of a small diameter accessory cord wrapped around a larger diameter rope – it acts as a “rope grab” on the larger rope.

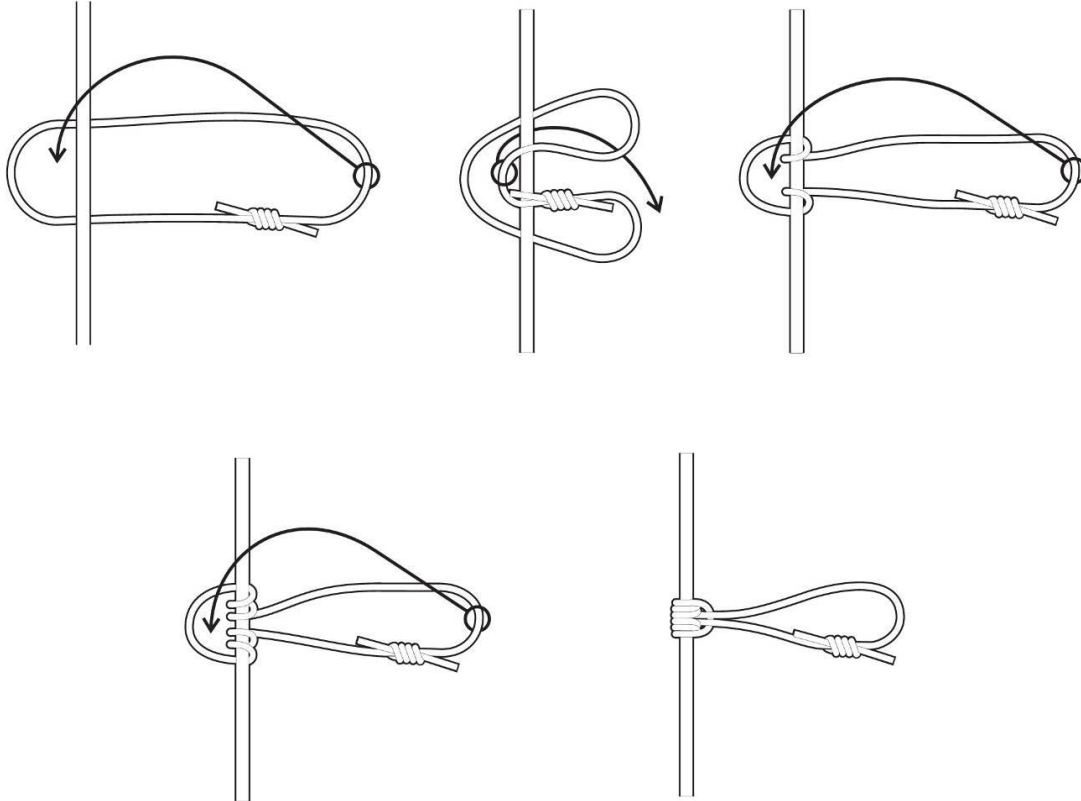

**Double-Wrap Prusik Hitch**